

PART NUMBER: 250-9634-NS

GENERAL APPLICABILITY

MAZDA 3 (AT/MT)

KIT CONTENTS/SERVICE PARTS

ITEM	QTY	DESCRIPTION	PART#
1	1	CRUISE CONTROL MODULE	250-2878
2	1	CLUTCH HARNESS	250-2759
3	1	SWITCH HARNESS	250-2760
4	1	PEDAL INTERFACE HARNESS	250-2871
5	1	CONTROL SWITCH	250-2867
6	1	DIAGNOSTICS HARNESS	250-2783

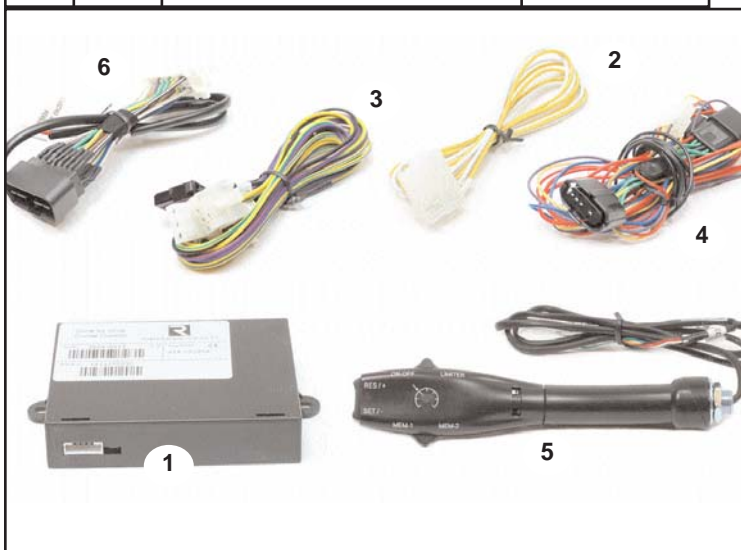

ITEM	QTY	DESCRIPTION
1	8	WIRE ZIP TIES
2		
3		

RECOMMENDED TOOLS

PERSONAL & VEHICLE PROTECTION	
SAFETY GLASSES	
SPECIAL TOOLS	
VOLT-OHM METER	
INSTALLATION TOOLS	
TRIM REMOVAL TOOL	PHILLIPS SCREWDRIVER
10-MM WRENCH	
DRILL BITS	9.5MM OR 3/8" (FOR SWITCH)
14MM WRENCH	
SOLDERING TOOL	
SPECIAL CHEMICALS	

CONFLICTS

NOTE: WATCH INSTRUCTION VIDEO
www.youtube.com/watch?v=I7NoO2DuvTG

LEGEND

- STOP:** DAMAGE TO VEHICLE MAY OCCUR. DO NOT PROCEED UNTIL PROCESS COMPLIANCE HAS BEEN MET.
- OPERATOR SAFETY:** USE CAUTION TO AVOID RISK OF INJURY.
- CRITICAL PROCESS:** PROCEED WITH CAUTION TO ENSURE A QUALITY INSTALLATION. THESE POINTS WILL BE AUDITED ON A COMPLETED VEHICLE INSTALLATION.
- GENERAL PROCESS:** THIS HIGHLIGHTS SPECIFIC PROCESSES TO ENSURE A QUALITY INSTALLATION. THESE POINTS WILL BE AUDITED DURING THE ACCESSORY INSTALLATION.
- TOOLS & EQUIPMENT:** THIS CALLS OUT THE SPECIFIC TOOLS AND EQUIPMENT REQUIRED FOR THE PROCESS.
- REVISION MARK:** THIS MARK HIGHLIGHTS A CHANGE IN INSTALLATION WITH RESPECT TO PREVIOUS ISSUE.



WARNING: DO NOT USE HAND-HELD 2-WAY TRANSCEIVERS INSIDE YOUR VEHICLE WHILE DRIVING.

WHEN TRANSMITTING FROM INSIDE THE CAR, 2-WAY RADIOS THAT OPERATE IN THE 25MHZ-700MHZ FREQUENCY RANGE WITH MORE THAN 2.0 WATTS OF POWER CAN PRODUCE ELECTROMAGNETIC INTERFERENCE THAT COULD INTERFERE WITH THE OPERATION OF CRUISE AND THROTTLE CONTROLS RESULTING IN VEHICLE "LIMP MODE".

USE OF CELLULAR PHONES WILL NOT INTERFERE WITH THESE CONTROLS.



DUE TO SENSITIVE NATURE OF SIGNALS USED FOR THIS PRODUCT, ALL NON-PLUG AND PLAY CONNECTIONS MUST BE SOLDERED. FAILURE TO COMPLY WITH THIS REQUIREMENT WILL VOID WARRANTY.

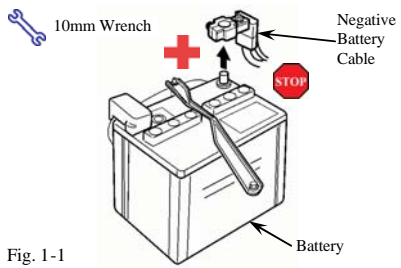

Accelerator Pedal Removal



Locate Accelerator Pedal as shown in above picture. Remove the 2 10 mm bolts that hold Accelerator Pedal to floor board. Once bolts are removed pedal assembly will fold out. Continue to next page for Accelerator Pedal harness instruction.

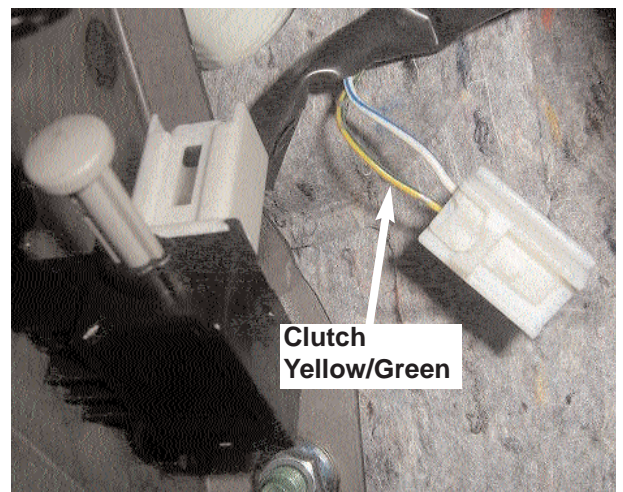
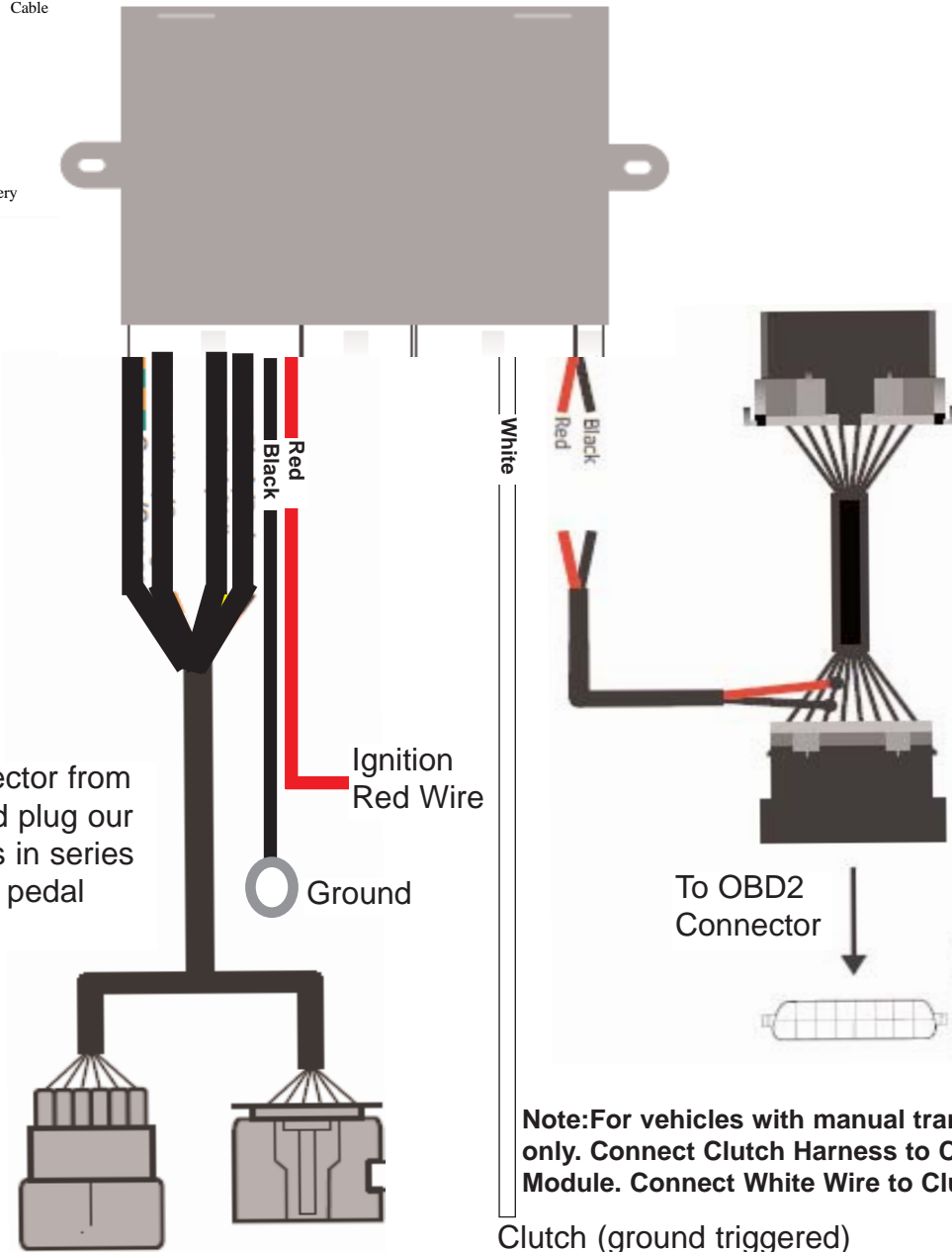
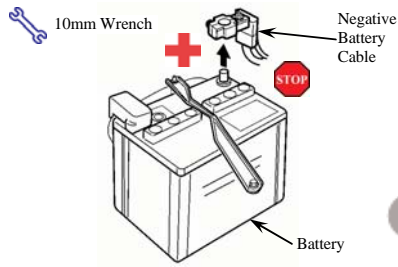

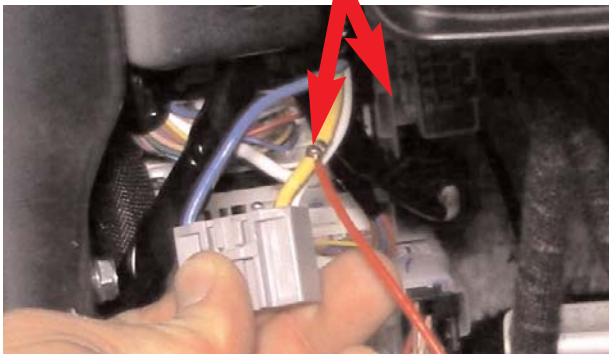
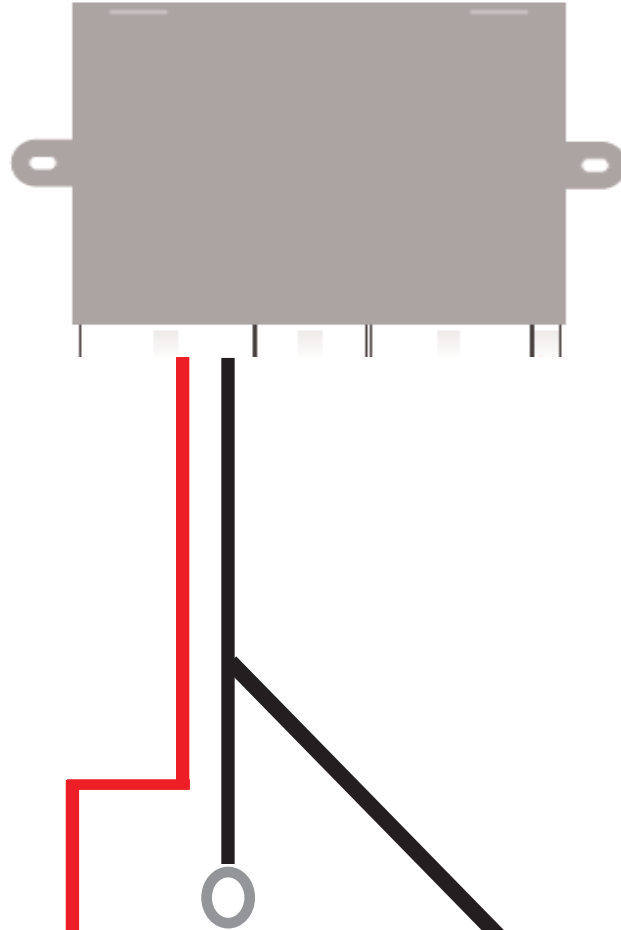

Below drivers dash near kick panel locate Gray connector in position 1 connect cruise red ignition wire to yellow wire for ignition power. Connector view shown unplugged with arrow pointing back to its location

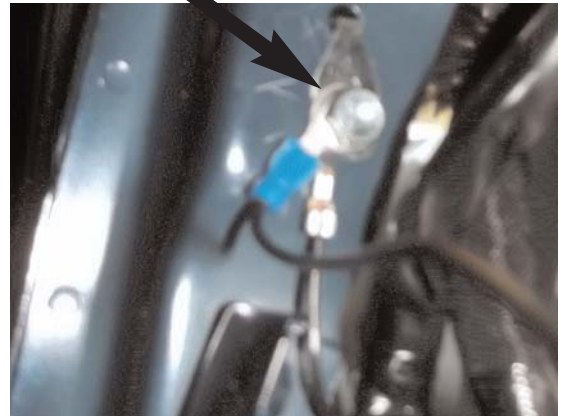

Drivers kick panel connect our Black wire to factory ground point shown in picture above

1. Find a suitable position for the switch on the left hand side of the covering around the steering column.
2. Mark the position and drill a 3/8 hole.
3. Use the enclosed fittings so the switch is angled to match the OE turn signal switch lever.
4. The switch head can be rotated as desired, and locked with the supplied retainer clip.
5. Insert the wires in the dconnectors to plug into cruise module shown below.

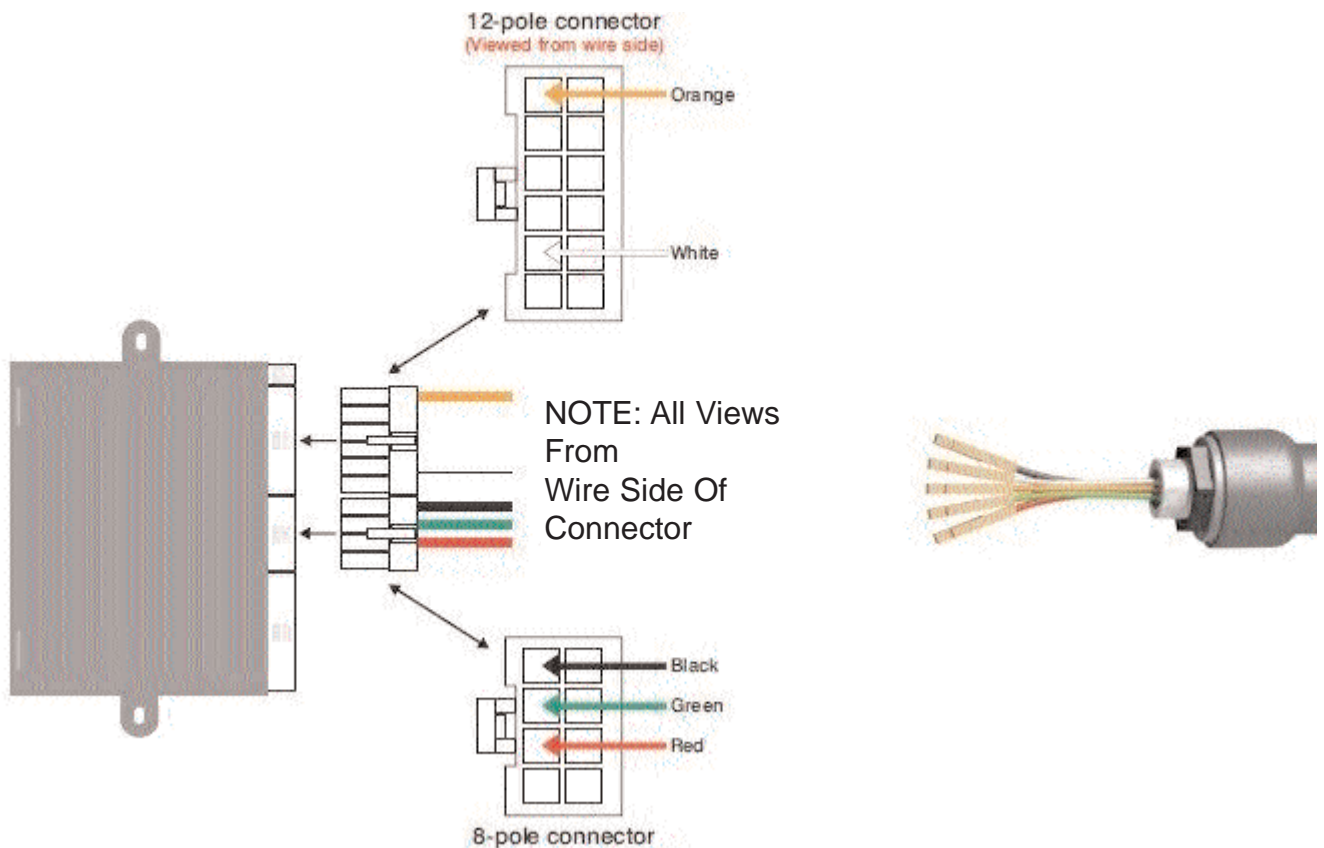
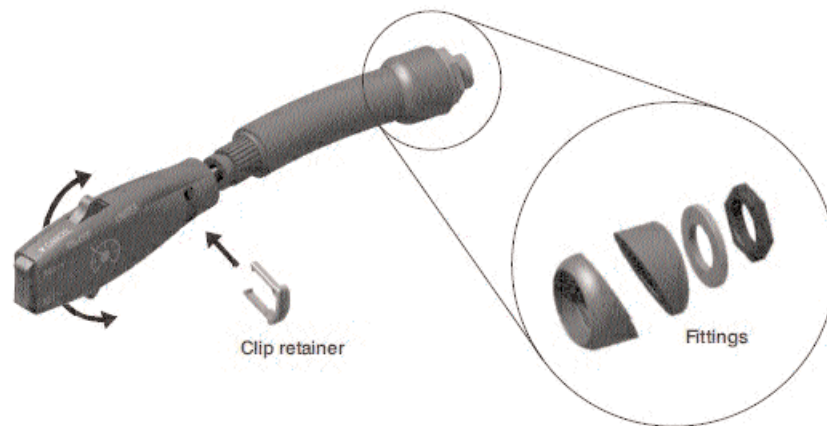

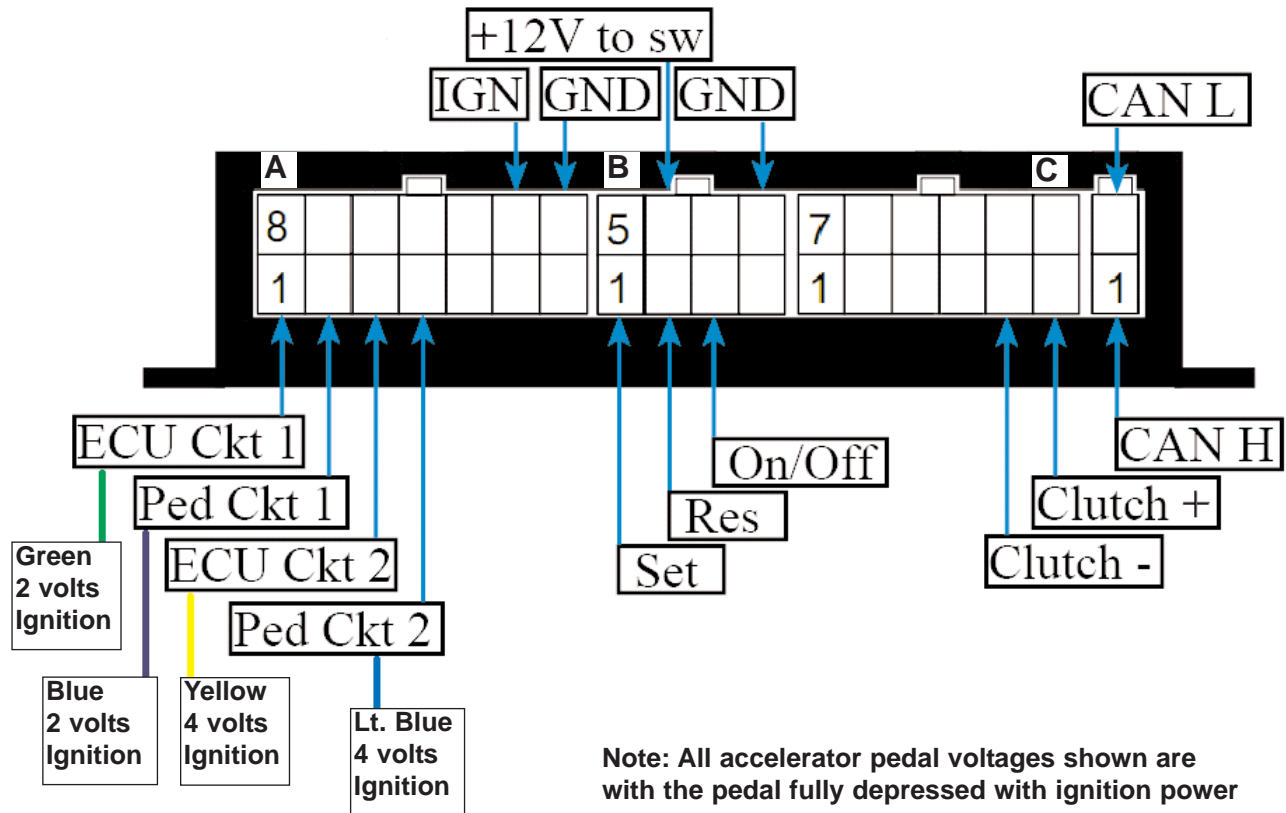

PIN	COLOR	DESIRED RESULTS	FAULT CONDITION
13A	RED	+12V WHEN SWITCHED ON AND +0V WHEN SWITCHED OFF. IGNITION MUST BE GREATER THAN +10V WHILE CRANKING VEHICLE.	NO POWER, VOLTAGE DROP, OR INTERMITTENT CONNECTION WILL CAUSE LOSS OF PEDAL OR "LIMP MODE" CONDITION.
14A	BLACK	LOWEST RESISTANCE TO GROUND AND CLOSEST TO ZERO (0) OHMS AS POSSIBLE. USE A VEHICLE GROUND POINT WHERE OTHER GROUND WIRES ARE CONNECTED TO.	A BAD GROUND CONNECTION WILL CAUSE THE FOLLOWING CONDITIONS: CRUISE WILL NOT FUNCTION, LOSS OF PEDAL OR "LIMP MODE" CONDITION.
1B	GREEN	SET/COAST: 12V PRESS AND HOLD SET	CRUISE WILL NOT SET IF THIS CONNECTION IS NOT INSTALLED CORRECTLY.
2B	YELLOW	RESUME/ACCEL: 12V PRESS AND HOLD RESUME	CRUISE WILL NOT RESUME OR ACCEL IF THIS CONNECTION IS NOT INSTALLED CORRECTLY.
3B	BROWN	ON/OFF: 12V PRESS ON	CRUISE WILL NOT SET IF THIS CONNECTION IS NOT INSTALLED CORRECTLY.
6B	RED AND BLUE	12V	CRUISE LIGHT WILL NOT COME ON IF THESE CONNECTIONS ARE NOT INSTALLED CORRECTLY.
8B	BLACK	(0) OHMS RESISTANCE TO GROUND	
5C	WHITE	GROUND ACTIVE WIRE AT SWITCH WHEN CLUTCH IS DEPRESSED.	CRUISE WILL NOT FUNCTION IF WRONG WIRE IS CONNECTED -OR- CRUISE WILL NOT DISENGAGE WHEN CLUTCH IS DEPRESSED.
6C	YELLOW	+12V ACTIVE WIRE AT SWITCH WHEN CLUTCH IS DEPRESSED.	

NOTES

NOTES

