

**PART NUMBER: 250-7500-NS1**

**KIT CONTENTS**

ITEM	QTY	DESCRIPTION
1	1	CONTROL MODULE
2	1	SWITCH
3	1	MICROPHONE
4	1	AUDIO/POWER HARNESS
5	1	WIRE TIES
6	1	2.25" X 2.25" VELCRO
7	1	.75" X .50" DOUBLE SIDED TAPE
8	1	FOAM TAPE
9	1	CONVOLUTED TUBING
10	1	OPERATION INSTRUCTIONS



**HARDWARE BAG CONTENTS**

ITEM	QTY	DESCRIPTION

**ADDITIONAL ITEMS REQUIRED FOR INSTALL**

ITEM	QTY	DESCRIPTION

**CONFLICTS**

--

**RECOMMENDED TOOLS**

PERSONAL & VEHICLE PROTECTION	
SAFETY GLASSES	
FENDER COVER	
GLOVES (OPTIONAL)	
SPECIAL TOOLS	
BATTERY POST PROTECTOR	
INSTALLATION TOOLS	
TRIM REMOVAL TOOL	
PHILIPS SCREWDRIVER	
10MM SOCKET	
3/4" DRIVE WRENCH	
SPECIAL CHEMICALS	

**GENERAL APPLICABILITY**

07-09 VERSA, 08-09 ALTIMA, 09 MAXIMA, 08-09 ROGUE, 09 MURANO, 08-09 FRONTIER/XTERRA, 07 PATHFINDER, 09 TITAN, 08 350Z, 09 QUEST, 2010 CUBE

**SERVICE PARTS**

ITEM	PART#	DESCRIPTION
	250-7504	SWITCH
	250-7507	CONTROL MODULE
	250-7508	MICROPHONE ASSEMBLY

**LEGEND**

**STOP** **STOP:** DAMAGE TO VEHICLE MAY OCCUR. DO NOT PROCEED UNTIL PROCESS COMPLIANCE HAS BEEN MET.

**+** **OPERATOR SAFETY:** USE CAUTION TO AVOID RISK OF INJURY.

**!** **CRITICAL PROCESS:** PROCEED WITH CAUTION TO ENSURE A QUALITY INSTALLATION. THESE POINTS WILL BE AUDITED ON A COMPLETED VEHICLE INSTALLATION.

**→** **GENERAL PROCESS:** THIS HIGHLIGHTS SPECIFIC PROCESSES TO ENSURE A QUALITY INSTALLATION. THESE POINTS WILL BE AUDITED DURING THE ACCESSORY INSTALLATION.

**🔧** **TOOLS & EQUIPMENT:** THIS CALLS OUT THE SPECIFIC TOOLS AND EQUIPMENT REQUIRED FOR THE PROCESS.

**||** **REVISION MARK:** THIS MARK HIGHLIGHTS A CHANGE IN INSTALLATION WITH RESPECT TO PREVIOUS ISSUE.

**🛡️** **VEHICLE PROTECTION:** THIS CALLS OUT FOR PROTECTION OF VEHICLE REQUIRED FOR THIS PROCESS.

**SPECIAL NOTE: INSTALLATION SEQUENCES**  
 AFTER SAFETY MANDATED PREPARATORY STEPS HAVE BEEN TAKEN, THE INSTALLATION SEQUENCE IS THE SUGGESTED METHOD FOR COMPLETING THE ACCESSORY INSTALLATION. IN SOME INSTANCES THE SUGGESTED SEQUENCE IS WRITTEN FOR ONE ASSOCIATE TO INSTALL AND IN OTHERS THE SEQUENCE IS GIVEN AS PART OF A TEAM ACCESSORY INSTALLATION. UNLESS OTHERWISE STATED IN THE DOCUMENT, THE ASSOCIATES MAY PERFORM THE INSTALLATION STEPS IN ANY ORDER TO MAKE THE INSTALLATION AS EFFICIENT AS POSSIBLE WHILE MAINTAINING CONSISTENT QUALITY.

INSTALLATION



**CAUTION: IT IS ADVISABLE TO DISCONNECT THE NEGATIVE BATTERY CABLE FOR 90 SECONDS BEFORE BEGINNING INSTALLATION TO AVOID UNINTENDED AIR BAG DEPLOYMENT FAILURE TO HEAD THIS WARNING MAY RESULT IN AIRBAG DISCHARGE AND MAY CAUSE SERIOUS INJURY OR DEATH.**  
**FIGURE 1**

**VERSA PREPARATION:**



1. DISENGAGE CLIPS TO REMOVE THE UPPER FINISH PANEL ABOVE THE RADIO BY USING A TRIM TOOL. **FIGURE 2**

2. REMOVE (2) PHILLIPS SCREWS AND DISENGAGE CLIPS TO RELEASE THE RADIO FINISH PANEL FROM THE RADIO ASSEMBLY. **FIGURE 3**

3. REMOVE (4) PHILLIPS SCREWS AND CAREFULLY REMOVE THE RADIO ASSEMBLY. DISCONNECT ALL CONNECTORS. **FIGURE 4**

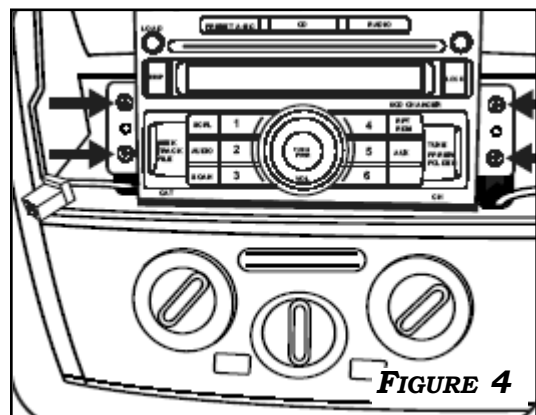
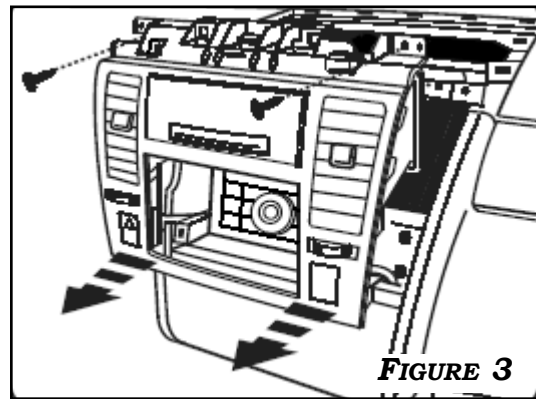
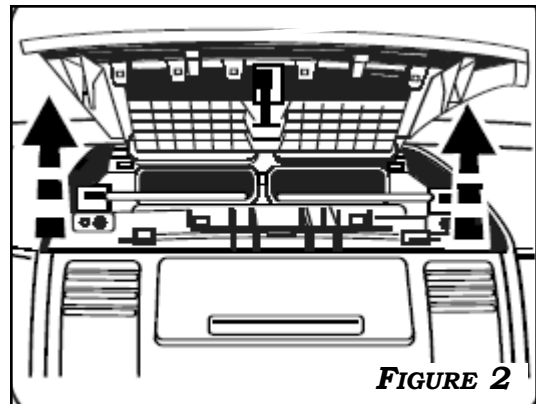
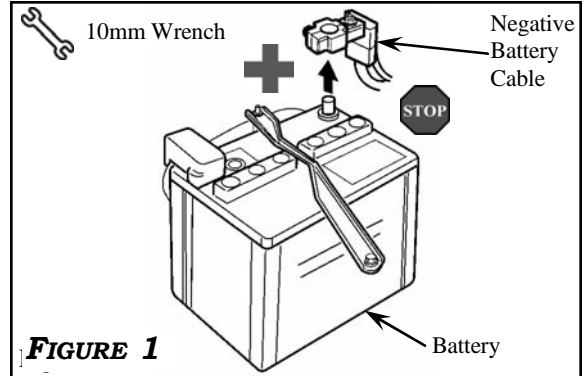

**VERSA PREPARATION: CONTINUED...**



4. USE A TRIM TOOL TO DISENGAGE CLIPS TO REMOVE THE LEFT SIDE DASH END COVER. THEN REMOVE LOWER FINISH PANEL BELOW THE STEERING WHEEL. **FIGURE 5**

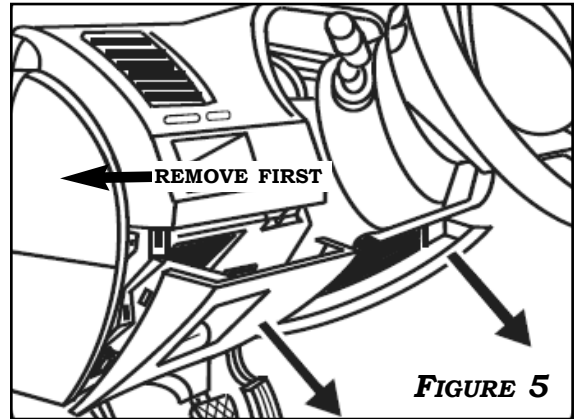

**FIGURE 5**

5. PRESS IN TABS TO REMOVE THE SWITCH BLANK PLUG FROM THE LOWER DASH FINISH PANEL. **FIGURE 6**

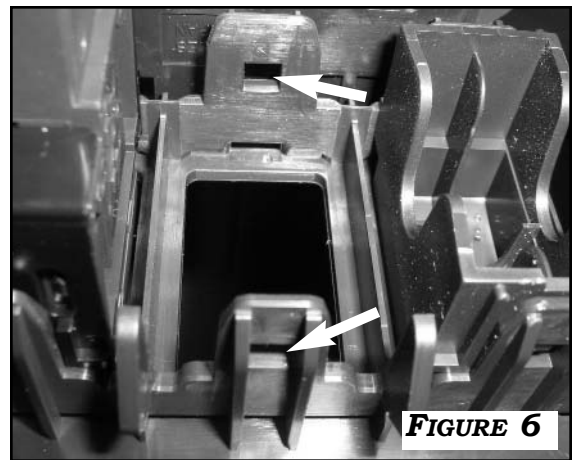
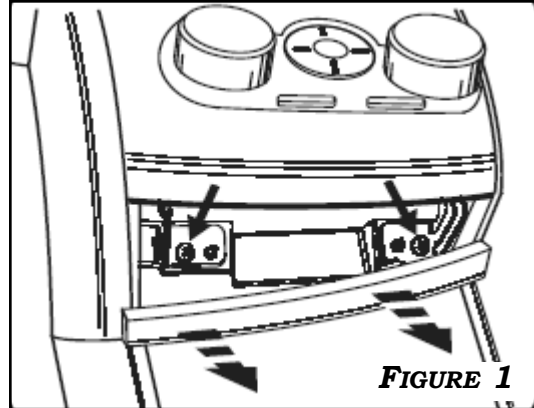

**FIGURE 6**

**ALTIMA PREPARATION:**



**1.** REMOVE THE LOWER FINISH PANEL ABOVE THE SHIFT LEVER BY USING A TRIM TOOL. REMOVE (2) PHILLIPS SCREWS BELOW RADIO/CLIMATE CONTROL FINISH PANEL. **FIGURE 1**



**2.** DISENGAGE CLIPS TO REMOVE THE CLIMATE CONTROL VENT FINISH PANEL. REMOVE (2) PHILLIPS SCREWS BEHIND FINISH PANEL. CAREFULLY REMOVE THE RADIO ASSEMBLY BY USING A TRIM TOOL TO DISENGAGE THE CLIPS. DISCONNECT ALL CONNECTORS FROM THE RADIO ASSEMBLY. **FIGURE 2**

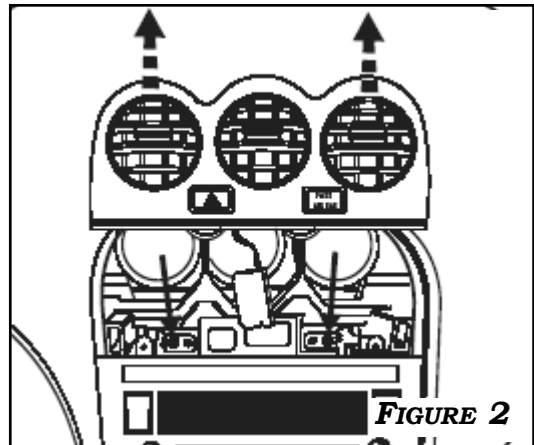

**3.** USE A TRIM TOOL TO DISENGAGE CLIPS TO REMOVE THE LEFT SIDE DASH END COVER. THEN REMOVE LOWER FINISH PANEL BELOW THE STEERING WHEEL. **FIGURE 3**

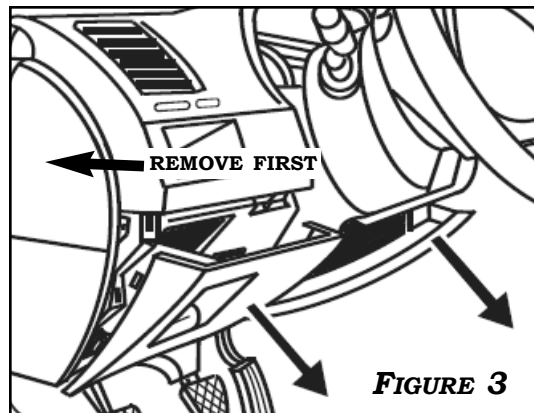

**5.** PRESS IN TABS TO REMOVE THE SWITCH BLANK PLUG FROM THE LOWER DASH FINISH PANEL. **FIGURE 4**

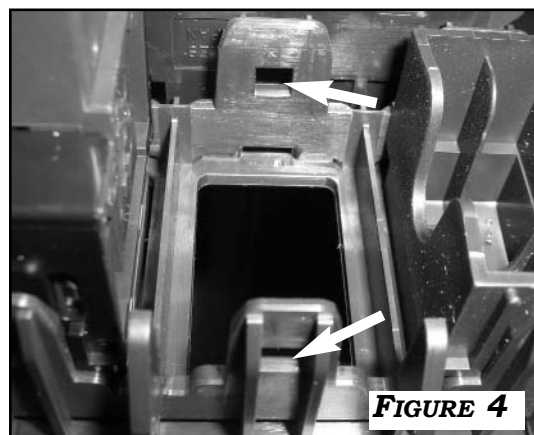

**MAXIMA PREPARATION:**



1. DISENGAGE CLIPS TO REMOVE THE CLIMATE CONTROL FINISH PANEL ABOVE THE RADIO ASSEMBLY. DISCONNECT THE CONNECTOR. **FIGURE 1**

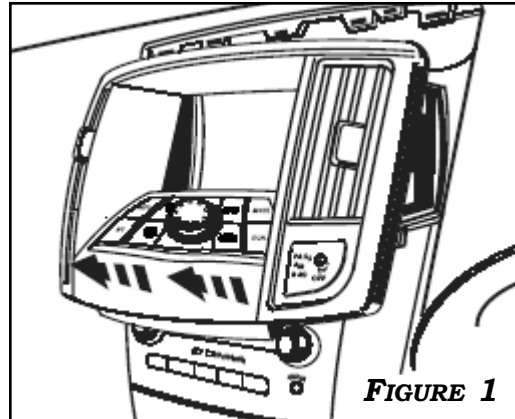

**FIGURE 1**

2. USE A TRIM TOOL TO DISENGAGE CLIPS AND REMOVE THE LOWER FINISH PANEL BELOW THE RADIO ASSEMBLY. **FIGURE 2**

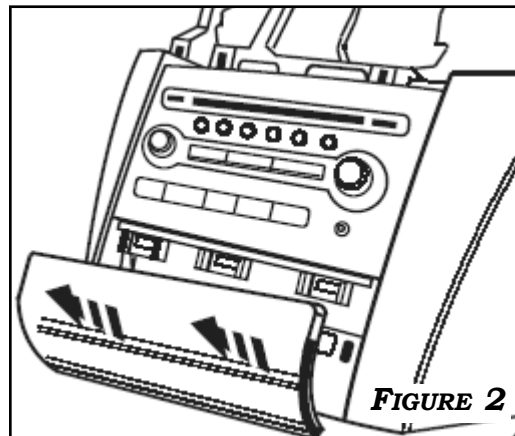

**FIGURE 2**

3. REMOVE (6) PHILLIPS SCREWS AND CAREFULLY REMOVE THE RADIO ASSEMBLY. DISCONNECT ALL CONNECTORS. **FIGURE 3**

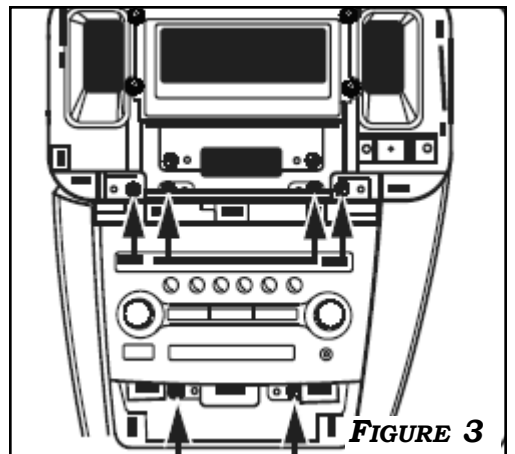

**FIGURE 3**

4. USE A TRIM TOOL TO DISENGAGE CLIPS TO REMOVE THE LEFT SIDE DASH END COVER. THEN REMOVE LOWER FINISH PANEL BELOW THE STEERING WHEEL. **FIGURE 4**

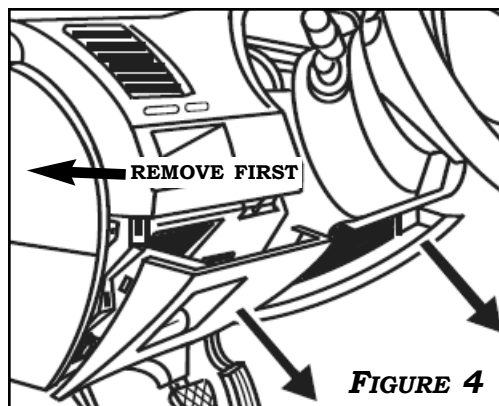

**FIGURE 4**

5. PRESS IN TABS TO REMOVE THE SWITCH BLANK PLUG FROM THE LOWER FINISH PANEL. **FIGURE 5**

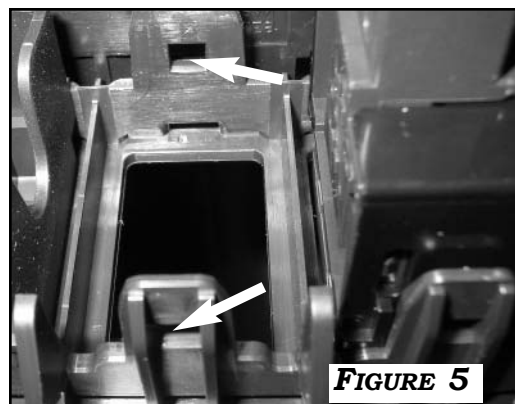

**FIGURE 5**

INSTALLATION

**ROGUE PREPARATION:**



**1. IF VEHICLE IS EQUIPPED WITH CENTER DASH SPEAKER:**  
 DISENGAGE CLIPS TO REMOVE THE SPEAKER COVER FINISH PANEL.  
**FIGURE 1**

**NOTE: IF VEHICLE IS NOT EQUIPPED WITH CENTER DASH SPEAKER,**  
 SKIP TO STEP 3.

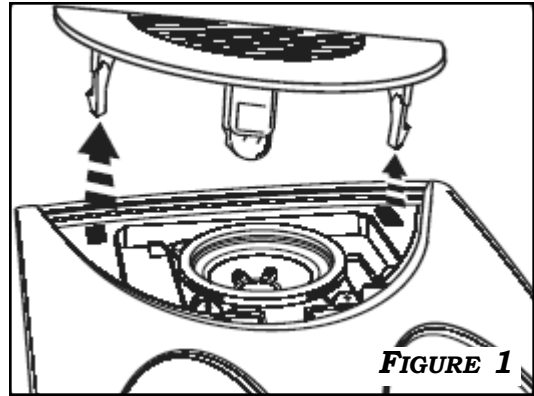

**2. REMOVE (4) PHILLIPS SCREWS TO RELEASE THE SPEAKER.**  
 DISCONNECT CONNECTOR TO REMOVE SPEAKER. **FIGURE 2**

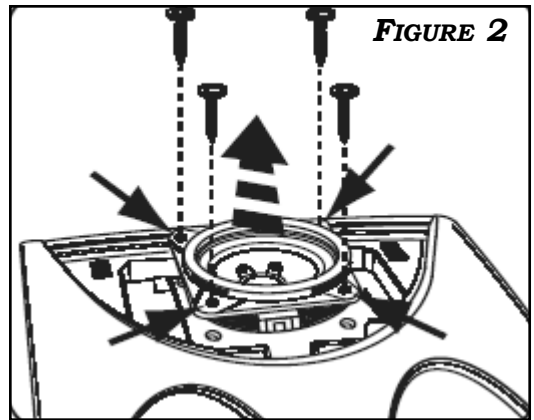

**3. DISENGAGE CLIPS TO REMOVE THE CLIMATE CONTROL VENT**  
 FINISH PANEL. DISCONNECT THE CONNECTOR TO THE HAZARD  
 SWITCH. **FIGURE 3**

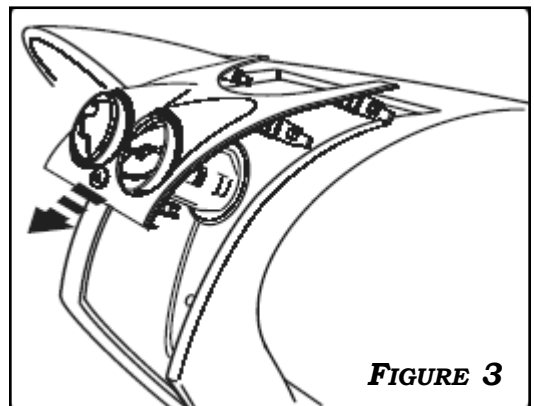

**ROGUE PREPARATION: CONTINUED...**



**4.** DISENGAGE CLIPS TO REMOVE THE CLIMATE CONTROL FINISH PANEL BELOW THE RADIO ASSEMBLY. DISCONNECT ALL CONNECTORS. **FIGURE 4**

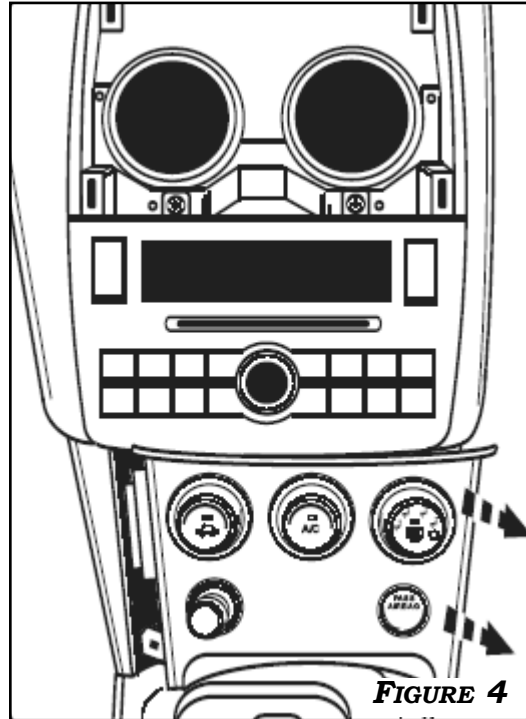

**FIGURE 4**

**5.** REMOVE (4) PHILLIPS SCREWS AND CAREFULLY REMOVE THE RADIO ASSEMBLY. DISCONNECT ALL CONNECTORS. **FIGURE 5**

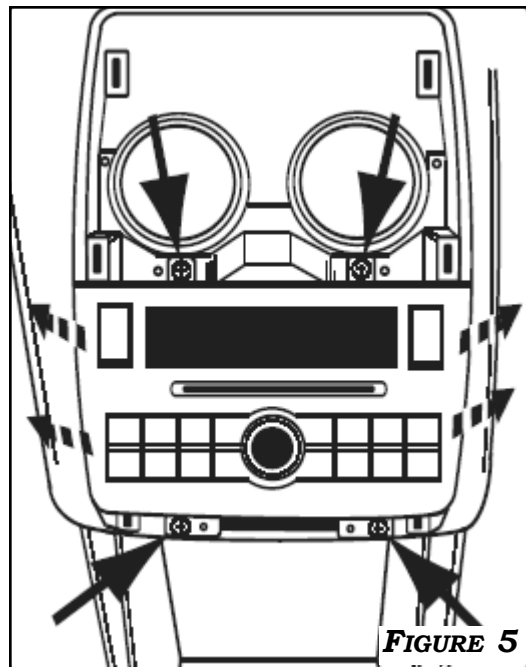
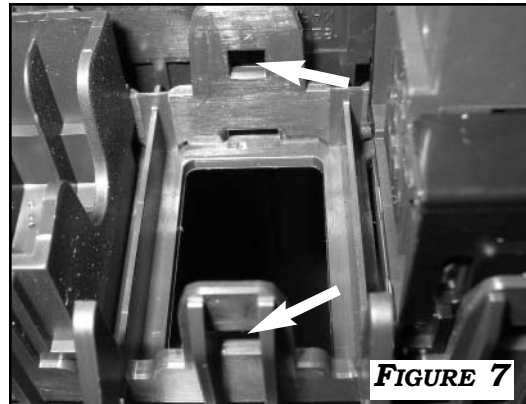

**FIGURE 5**

**6.** USE A TRIM TOOL TO REMOVE THE SIDE MIRROR CONTROL FINISH PANEL. **FIGURE 6**



**FIGURE 6**



**FIGURE 7**

INSTALLATION

**MURANO PREPARATION:**



1. DISENGAGE CLIPS TO REMOVE THE LOWER FINISH PANEL BELOW THE RADIO ASSEMBLY. **FIGURE 1**

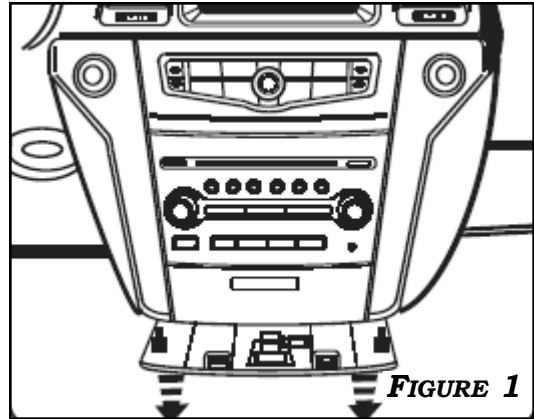

**FIGURE 1**

2. REMOVE (1) PHILLIPS SCREW AT THE BOTTOM OF THE LEFT AND RIGHT SIDE FINISH PANELS. DISENGAGE CLIPS TO REMOVE BOTH PANELS. **FIGURE 2**

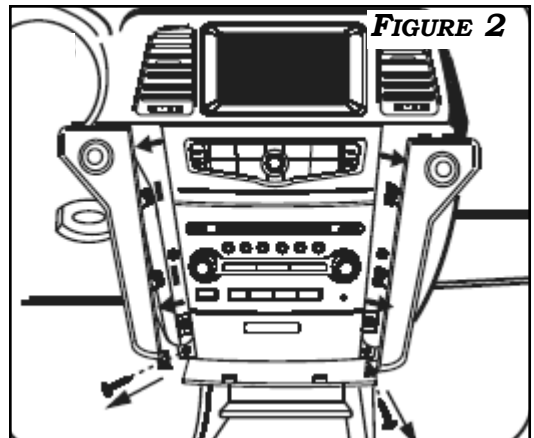

**FIGURE 2**

3. REMOVE (3) PHILLIPS SCREWS TO RELEASE THE CLIMATE CONTROL UNIT. DISENGAGE CLIPS AND DISCONNECT CONNECTOR TO REMOVE THE CLIMATE CONTROL UNIT. **FIGURE 3**

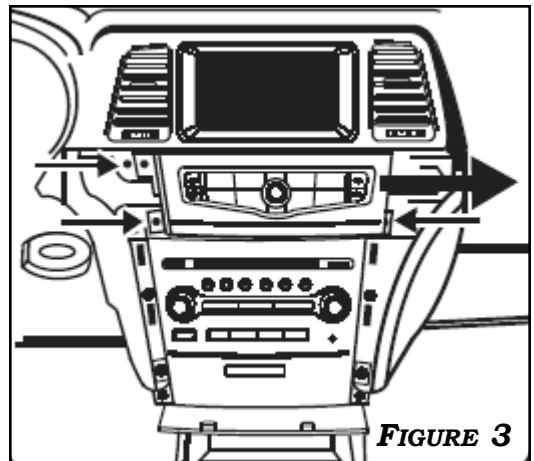

**FIGURE 3**

4. REMOVE (3) PHILLIPS SCREWS TO RELEASE THE AIRBAG LIGHT FINISH PANEL. DISENGAGE CLIPS AND DISCONNECT CONNECTOR TO REMOVE THE PANEL. **FIGURE 4**

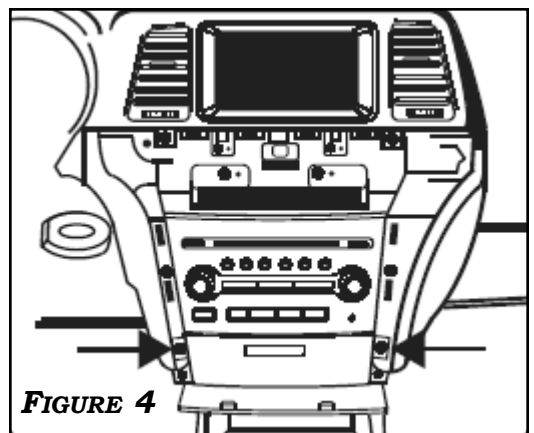

**FIGURE 4**



**MURANO PREPARATION: CONTINUED...**



**5.** REMOVE (6) PHILLIPS SCREWS AND CAREFULLY REMOVE THE RADIO ASSEMBLY. DISCONNECT ALL CONNECTORS. **FIGURE 5**

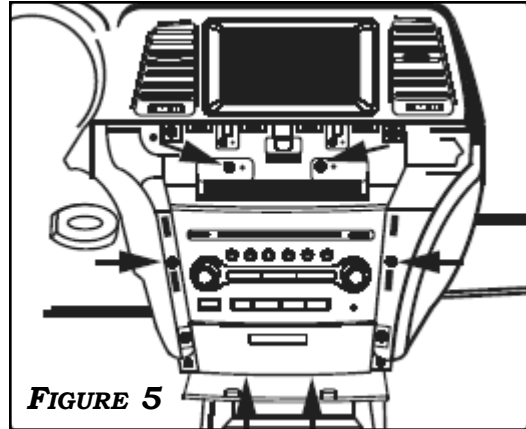

**FIGURE 5**

**6.** USE A TRIM TOOL TO DISENGAGE CLIPS TO REMOVE THE LEFT SIDE DASH END COVER. THEN REMOVE LOWER FINISH PANEL BELOW THE STEERING WHEEL. **FIGURE 6**

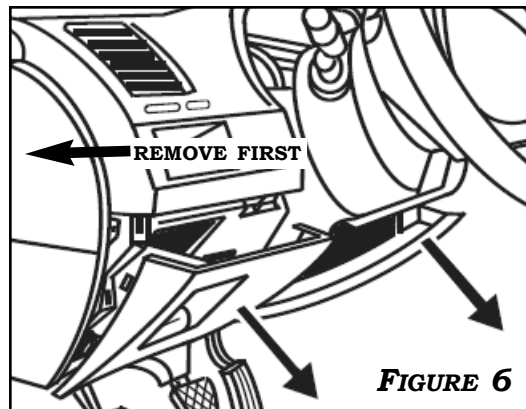

**FIGURE 6**

**7.** PRESS IN TABS TO REMOVE THE SWITCH BLANK PLUG FROM THE LOWER FINISH PANEL. **FIGURE 7**

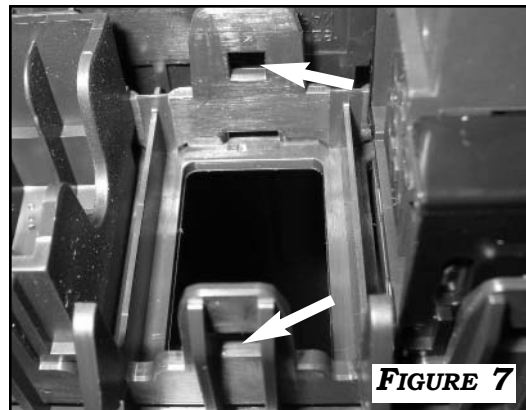

**FIGURE 7**

INSTALLATION

**PATHFINDER/FRONTIER/XTERRA/TITAN  
PREPARATION:**

**NOTE: FOR FRONTIER/XTERRA BEGIN WITH  
STEP 3. FOR TITAN BEGIN WITH STEP 4.**



**1. DISENGAGE CLIPS TO REMOVE THE FINISH PANEL AROUND THE  
CUP HOLDER BELOW THE SHIFT LEVER. FIGURE 1**

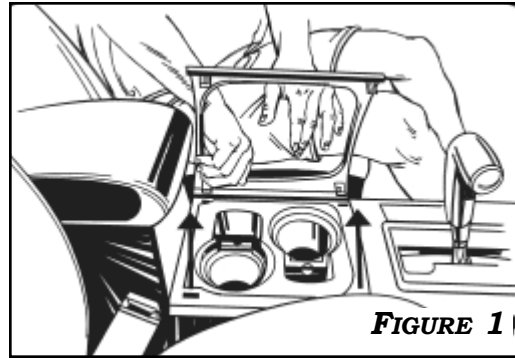

**FIGURE 1**

**2. DISENGAGE CLIPS AND REMOVE FINISH PANEL SURROUNDING  
THE SHIFT LEVER. FIGURE 2**

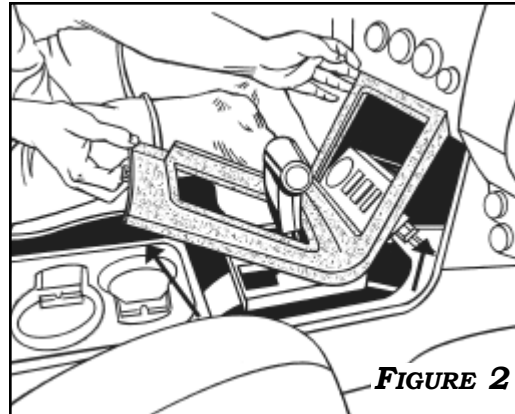

**FIGURE 2**

**3. DISENGAGE CLIPS TO REMOVE THE FINISH PANEL TRAY ABOVE  
THE RADIO ASSEMBLY. REMOVE PHILLIPS SCREW FROM BEHIND.  
FIGURE 3**

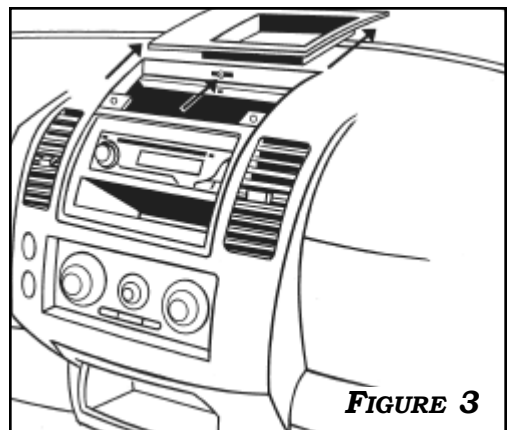

**FIGURE 3**

**4. FOR PATHFINDER/FRONTIER/XTERRA: DISENGAGE CLIPS AND  
REMOVE FINISH PANEL SURROUNDING THE RADIO ASSEMBLY.  
FIGURE 4.**

**FOR TITAN: DISENGAGE CLIPS TO REMOVE THE RADIO ASSEM-  
BLY FINISH PANEL CONTAINING THE CLIMATE CONTROL. DISCONNECT  
CONNECTOR. FIGURE 5**

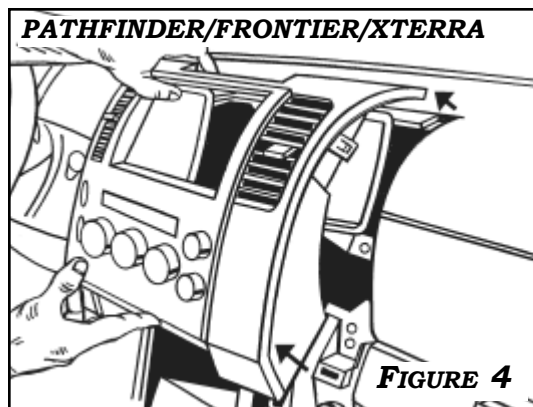

**FIGURE 4**

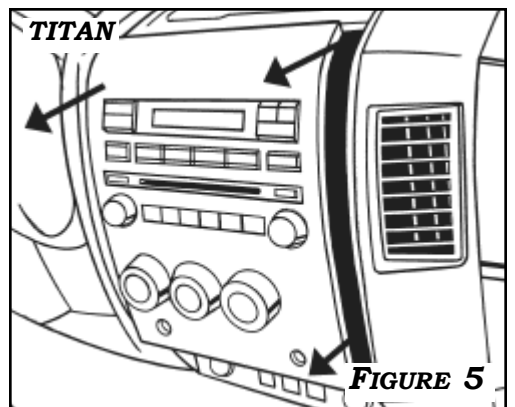

**FIGURE 5**

INSTALLATION

**PATHFINDER/FRONTIER/XTERRA/TITAN**

**PREPARATION: CONTINUED...**



5. REMOVE (4) PHILLIPS SCREWS AND CAREFULLY REMOVE THE RADIO ASSEMBLY. DISCONNECT ALL CONNECTORS. FOR PATHFINDER/FRONTIER/XTERRA: SEE **FIGURE 6**. FOR TITAN: SEE **FIGURE 7**.

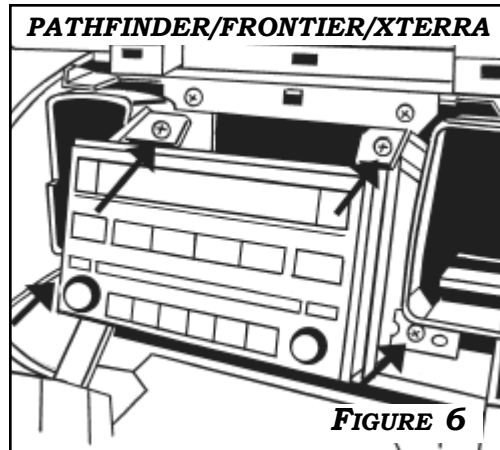

6. USE A TRIM TOOL TO DISENGAGE CLIPS TO REMOVE THE LEFT SIDE DASH TRIM COVER. REMOVE PHILLIPS SCREW FROM BEHIND. THEN REMOVE LOWER FINISH PANEL BELOW THE STEERING WHEEL. **FIGURE 8**

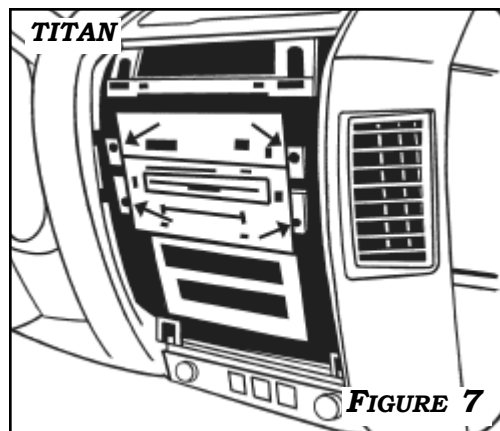

7. PRESS IN TABS TO REMOVE THE SWITCH BLANK PLUG FROM THE LOWER FINISH PANEL. **FIGURE 9**

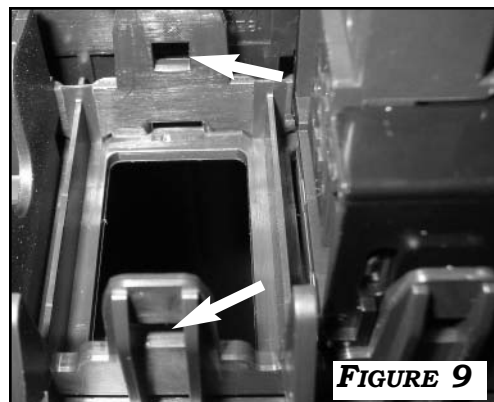
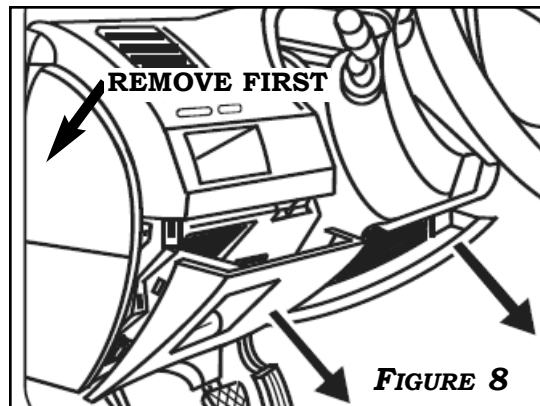

INSTALLATION

350Z PREPARATION:



1. IF VEHICLE IS EQUIPPED: REMOVE THE TRIM RING FINISH PANEL. **FIGURE 1**

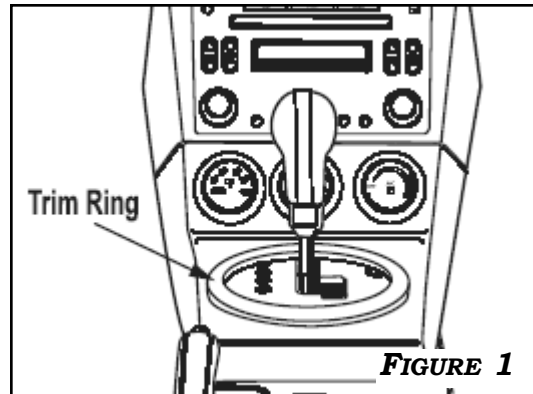

2. DISENGAGE CLIPS TO REMOVE THE CENTER CONSOLE FINISH PANEL SURROUNDING THE SHIFT LEVER. **FIGURE 2**

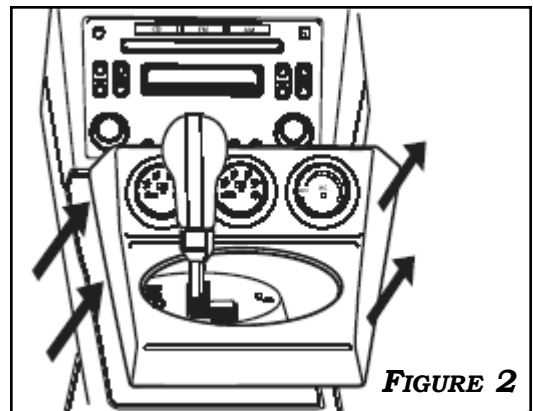

3. IF VEHICLE IS EQUIPPED WITH NAVIGATION: DISENGAGE CLIPS TO REMOVE THE NAVIGATION SWITCH FINISH PANEL. **FIGURE 3**

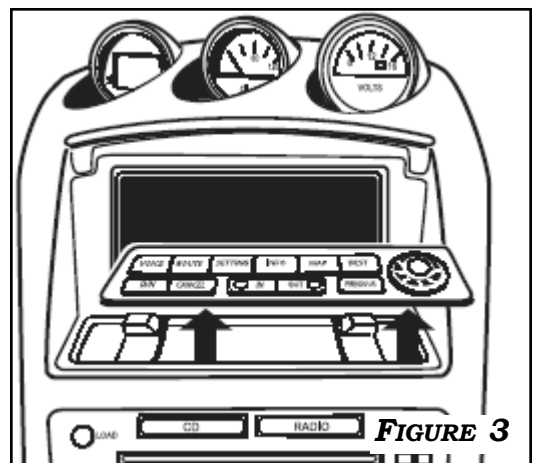

4. IF VEHICLE IS EQUIPPED WITHOUT NAVIGATION: REMOVE THE COMPARTMENT MAT, REMOVE (2) SCREWS FROM BEHIND TO RELEASE SWITCH MASK. **FIGURE 4**

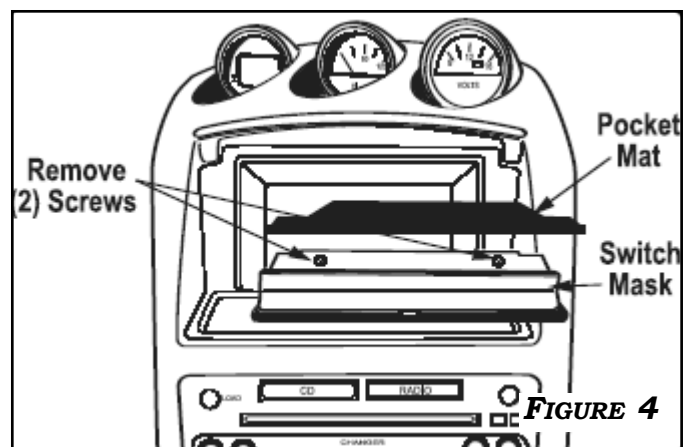

**350Z PREPARATION: CONTINUED...**



**5.** REMOVE (4) PHILLIPS SCREWS TO RELEASE THE RADIO ASSEMBLY. REMOVE (2) SCREWS TO RELEASE THE FINISH PANEL SURROUNDING THE RADIO ASSEMBLY. **FIGURE 5**

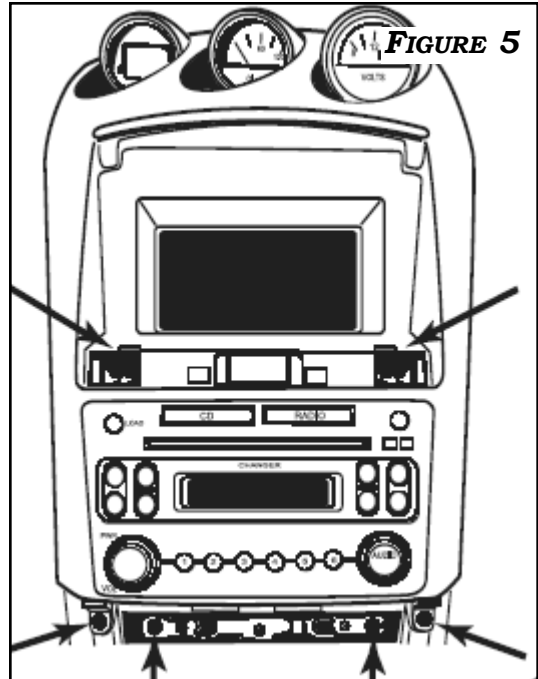

**6.** CAREFULLY REMOVE THE RADIO/FINISH PANEL ASSEMBLY. DISCONNECT ALL CONNECTORS. **FIGURE 6**

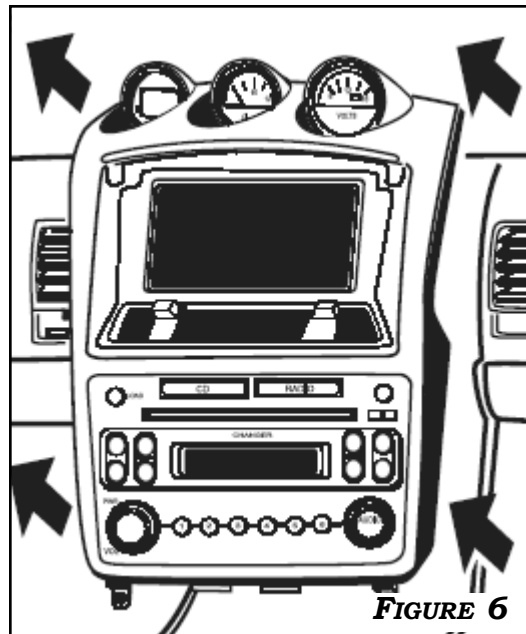

**7.** USE A TRIM TOOL TO REMOVE THE CENTER CONSOLE FINISH PANEL. **FIGURE 7**

**8.** PRESS IN TABS TO REMOVE THE SWITCH BLANK PLUG FROM THE CENTER CONSOLE FINISH PANEL. **FIGURE 8**

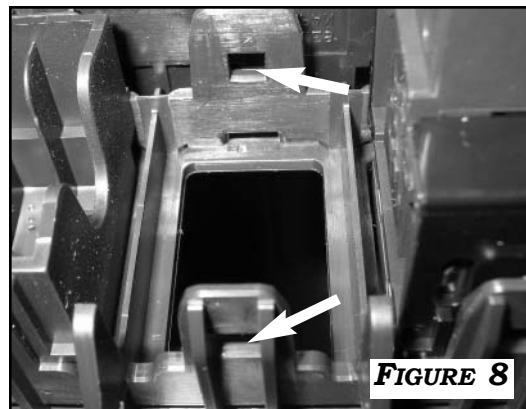

### MICROPHONE



1. ROUTE THE MICROPHONE HARNESS TO AN AREA ON OR NEAR THE DASHBOARD AWAY FROM SIDE AIRBAGS OR VENTS. USE THE VEHICLE WIRING CLIPS AND SUPPLIED WIRE TIES TO SECURE HARNESSES. USING THE DOUBLE SIDED TAPE, PLACE THE MICROPHONE IN THE SELECTED AREA AS SHOWN IN **FIGURE 1**.

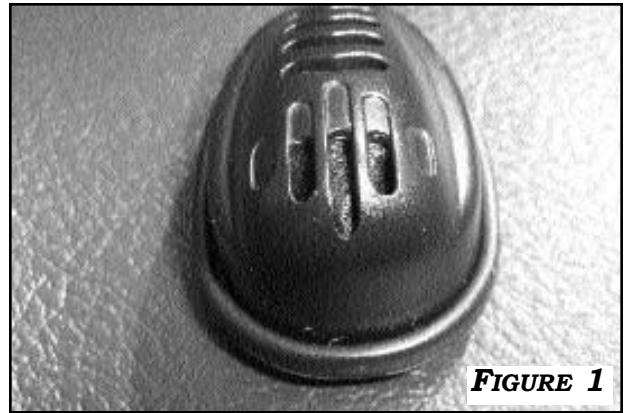

### CONTROL SWITCH



1. INSERT THE CONTROL SWITCH INTO THE REMOVED SWITCH BLANK FINISH PANEL. **THE SOLID TRIANGLE SHOULD BE AT THE TOP OF THE SWITCH. FIGURES 2-11.** ROUTE THE SWITCH HARNESS ALONG THE EXISTING VEHICLE WIRING BEHIND THE DASHBOARD TO THE CENTER CONSOLE AREA. SECURE HARNESSES WITH WIRE TIES.



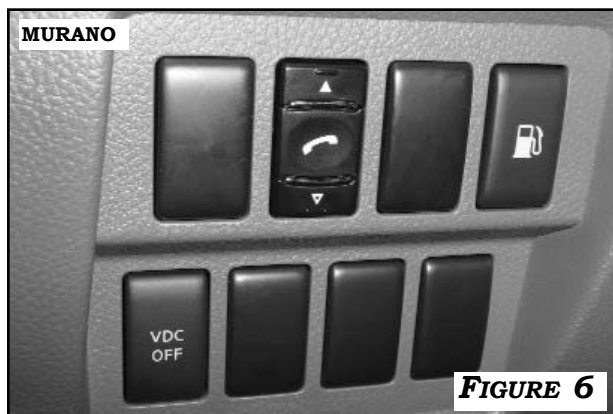

## INTERFACE MODULE



1. CONNECT ALL HARNESSES TO THE INTERFACE MODULE.  
**FIGURE 12.**

2. MOUNT THE INTERFACE MODULE NEAR THE JUNCTION BOX OR BEHIND THE RADIO ASSEMBLY. USE WIRES TIES TO SECURE THE MODULE AS SHOWN IN **FIGURE 13.**

## AUDIO/POWER HARNESS



1. PRESS IN WHITE TAB TO REMOVE CONNECTOR FROM THE RADIO ASSEMBLY.

2. CONNECT THE POWER/AUDIO HARNESS TO THE RADIO ASSEMBLY. CONNECT THE RADIO ASSEMBLY HARNESS SIDE TO THE MATING CONNECTORS ON THE POWER/AUDIO HARNESS. APPLY THE GROUND TERMINAL FROM THE BLACK WIRE ON THE POWER/AUDIO HARNESS TO AN AVAILABLE SCREW ON RADIO MOUNTING BRACKET. SECURE HARNESSES WITH WIRE TIES. **FIGURE 14.**

## REASSEMBLY AND TESTING



**CAUTION: RECONNECT THE PASSENGER SIDE AIRBAG LIGHT BEFORE CONNECTING THE NEGATIVE BATTERY CABLE WHEN TESTING THE SYSTEM. FAILURE TO DO THIS WILL ACTIVATE THE AIRBAG FAIL CODE ON THE VEHICLE.**

1. RECONNECT NEGATIVE BATTERY CABLE AND TORQUE TO **36 IN\*LBS.**
2. REINSTALL ALL TRIM PIECES TAKING SPECIAL CARE TO ENSURE HARNESSES AND WIRE CONNECTIONS ARE PROPERLY SECURED.
3. BE SURE HARNESSES IS NOT PINCHED OR BOUND BY TRIM PIECES.
4. BE SURE TO RECONNECT HOOD RELEASE CABLE.



**FIGURE 12**

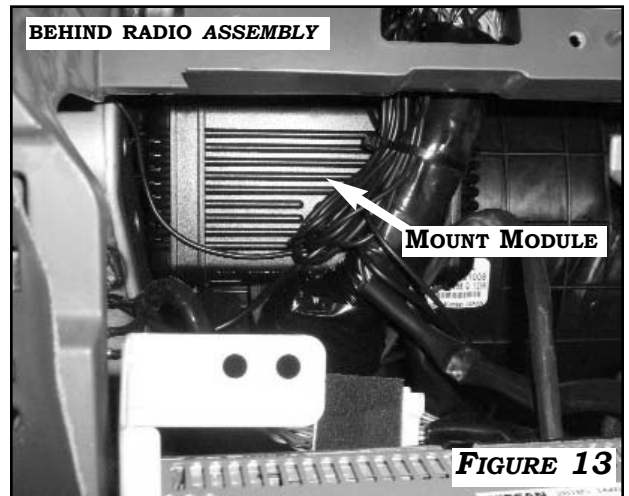

**BEHIND RADIO ASSEMBLY**

**MOUNT MODULE**

**FIGURE 13**

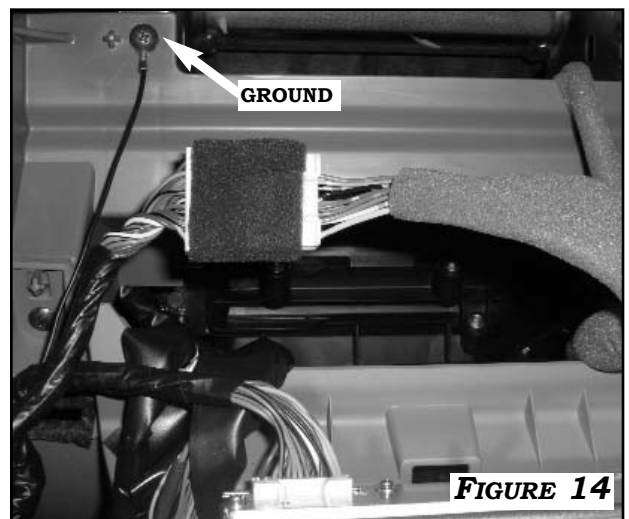

**GROUND**

**FIGURE 14**